



4441

CITY



1

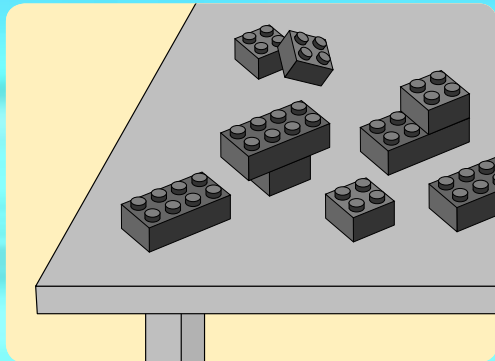
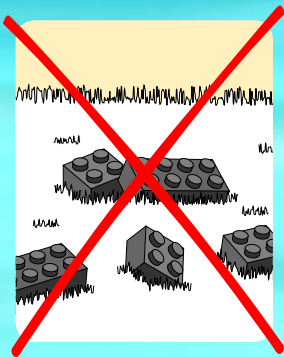

2

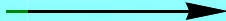

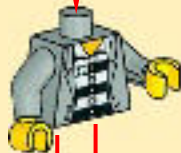

1

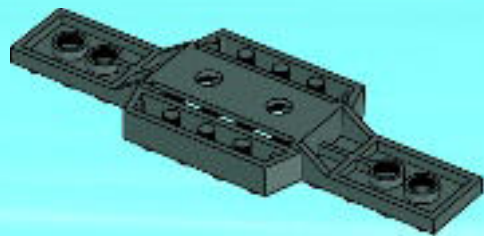

2

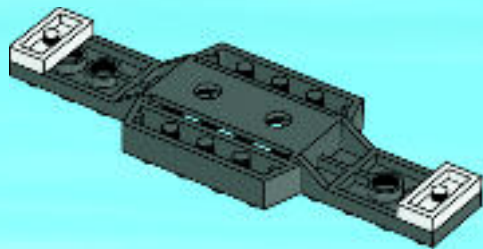

3

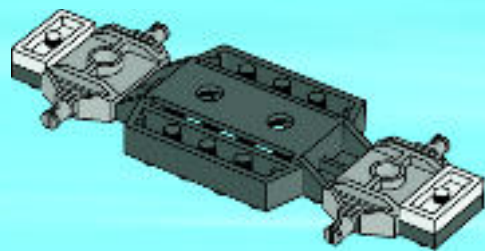

4



5



6

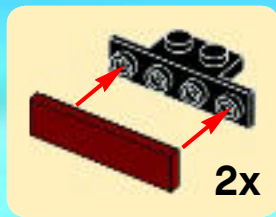

7



8

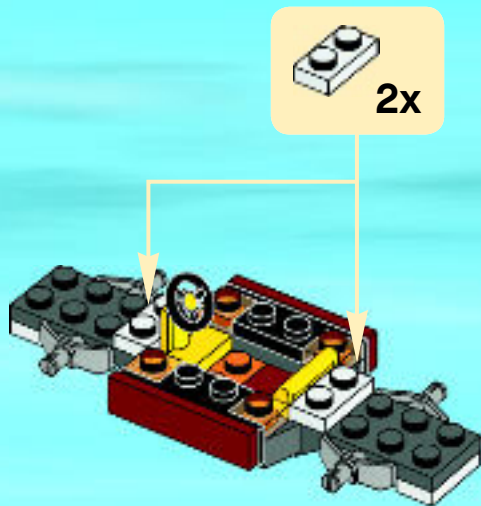

9



10



11

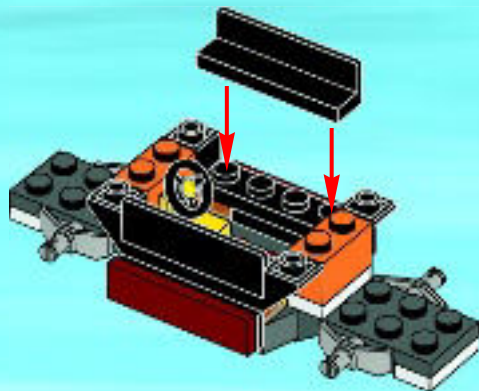

12

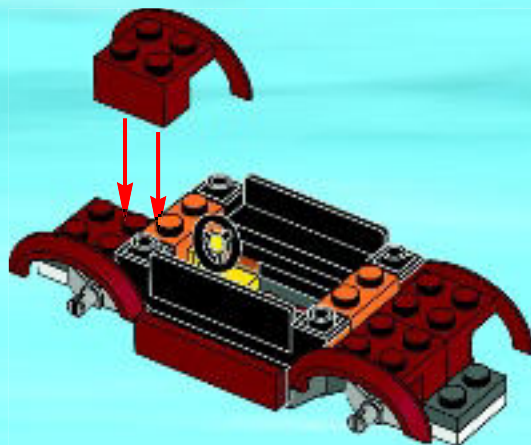

13



14

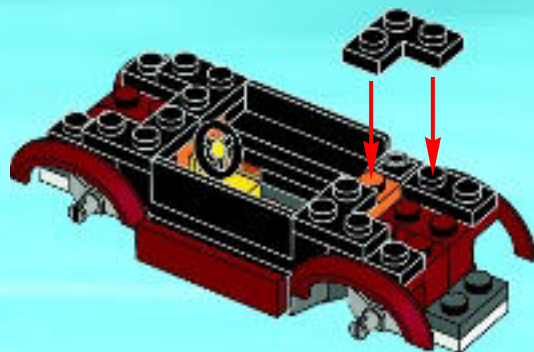

1



2



3

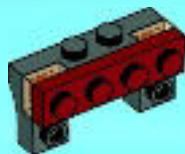

4

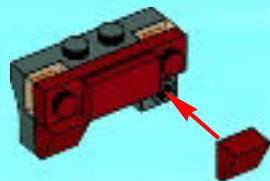

5



15



16



17

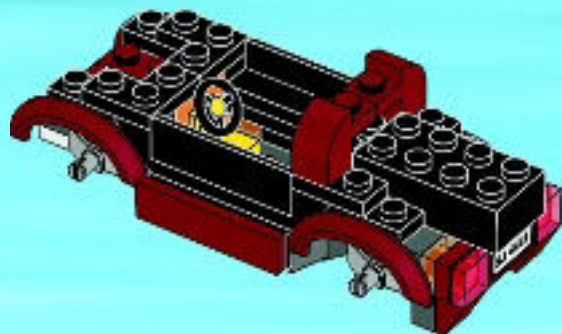

18

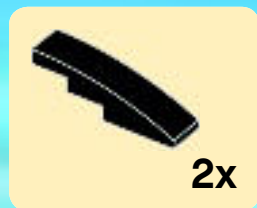
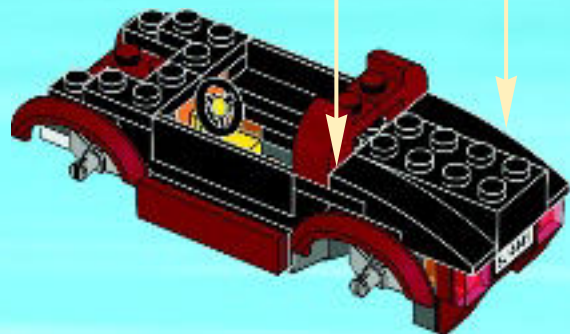

19

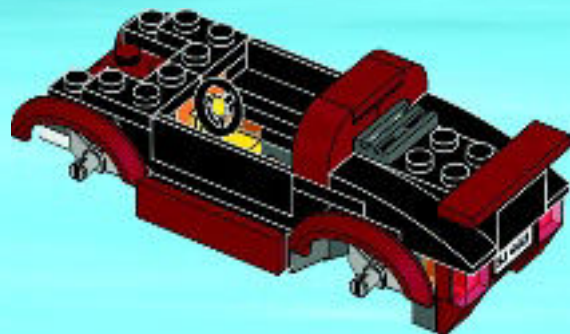

1

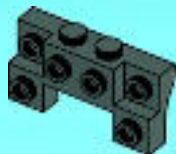

2



3



4

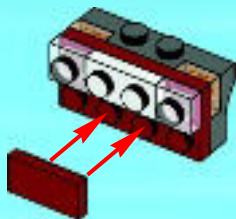

5

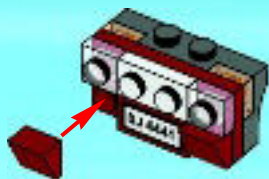

6



20

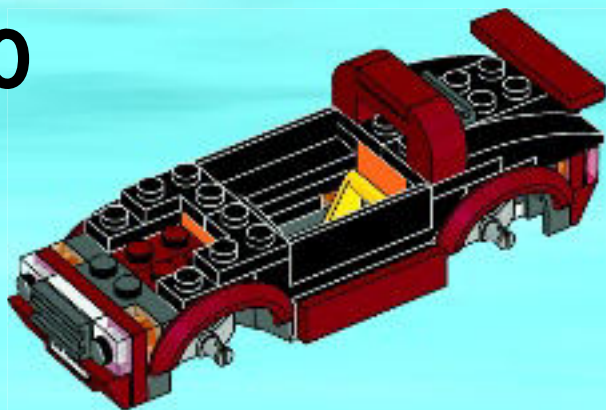

21

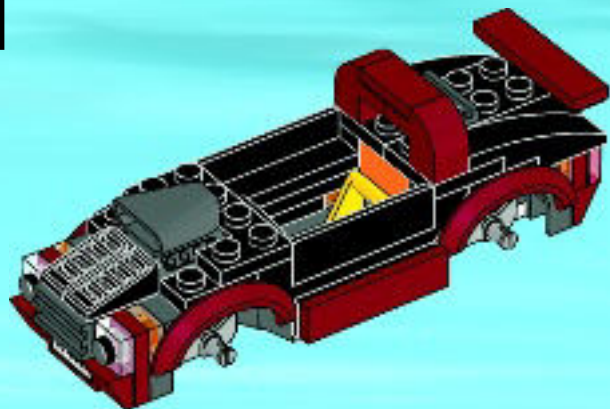

22

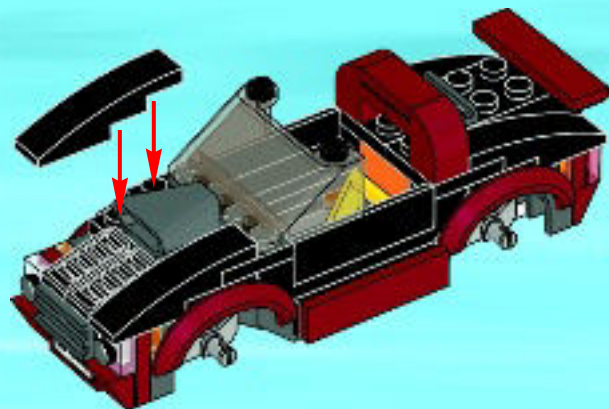

23

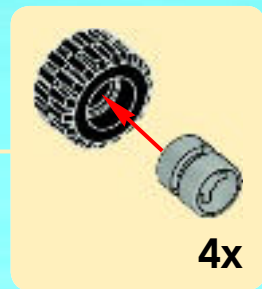
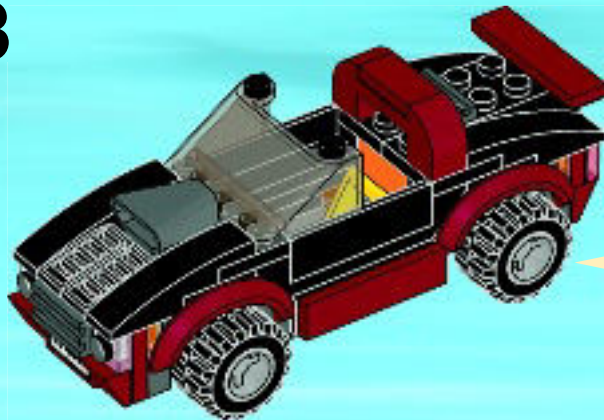



1

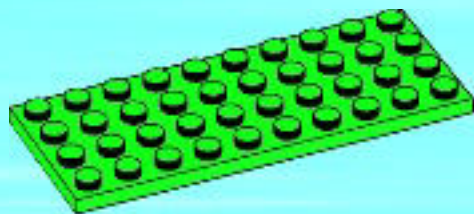

2

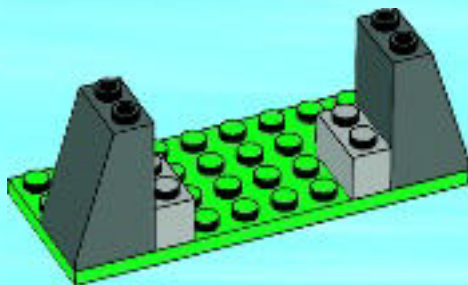

3

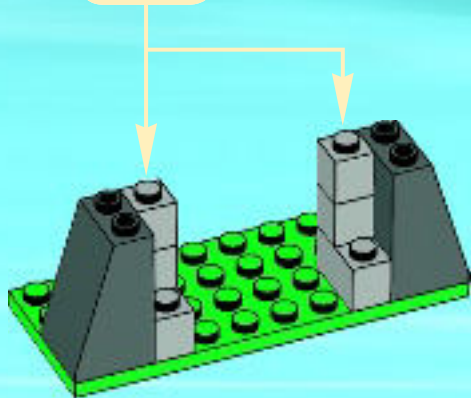
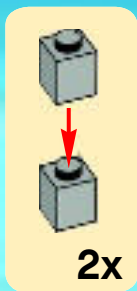

4

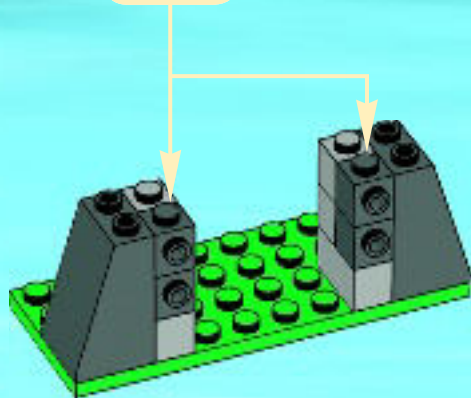
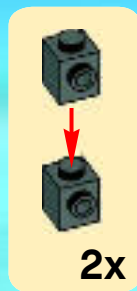

5

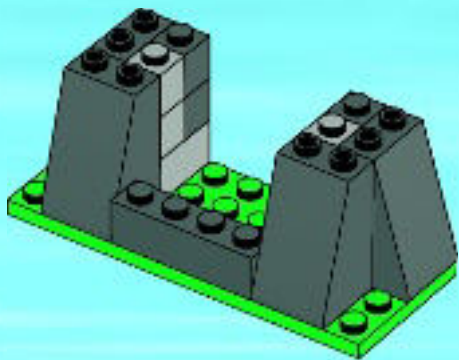

6

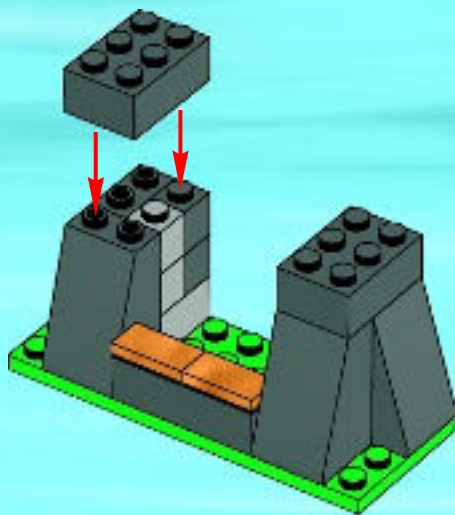

7

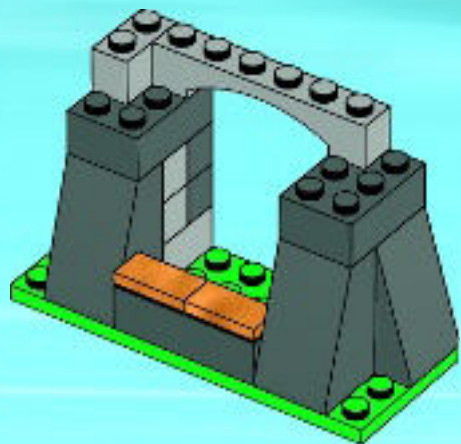

8

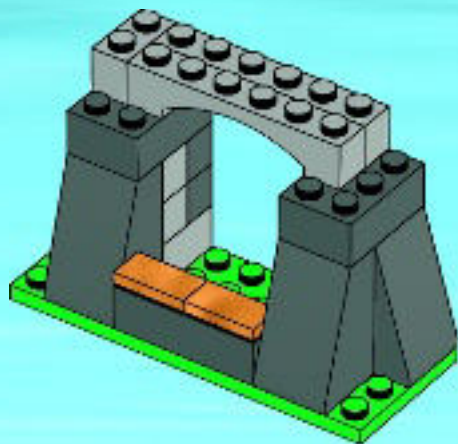

9

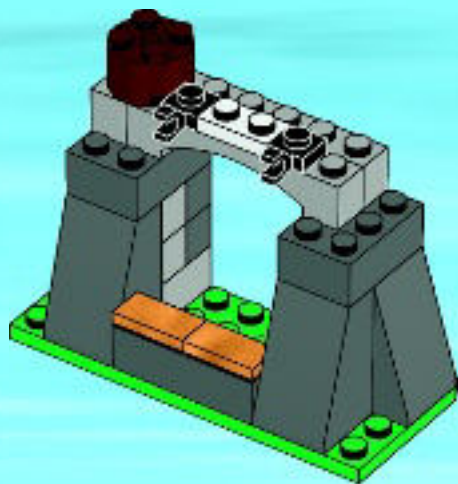

10

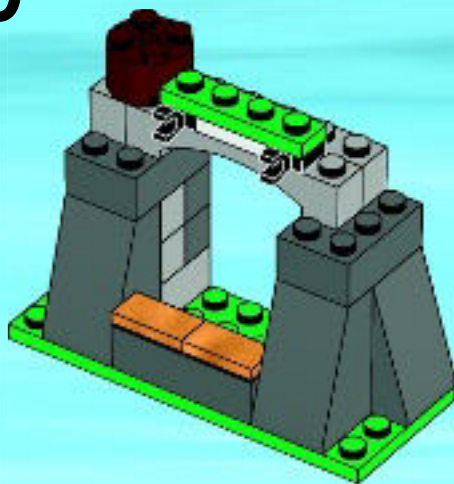

11

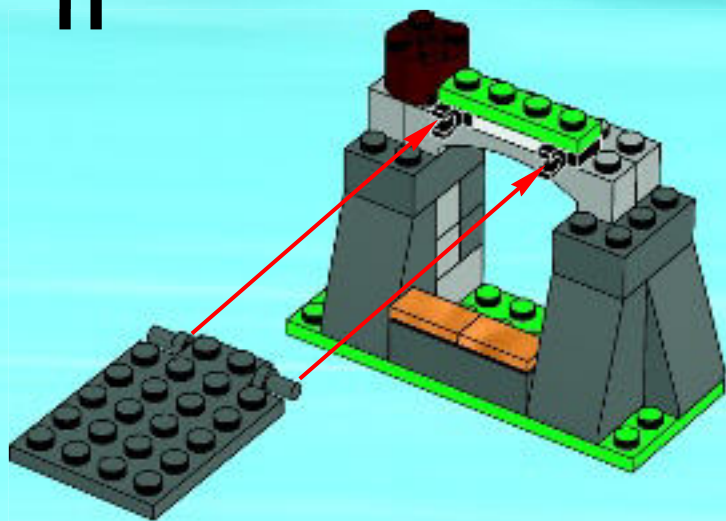

12

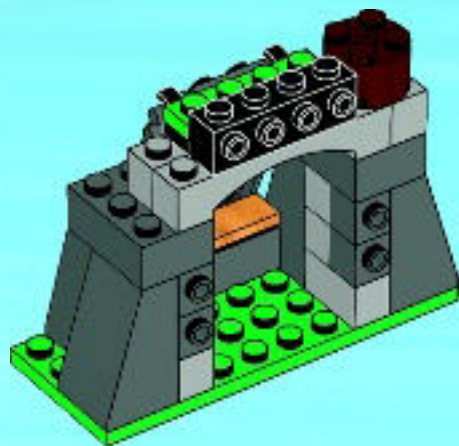

13



14

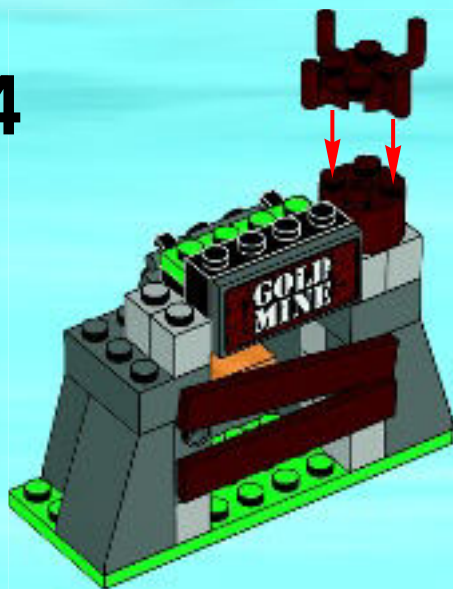

15



16

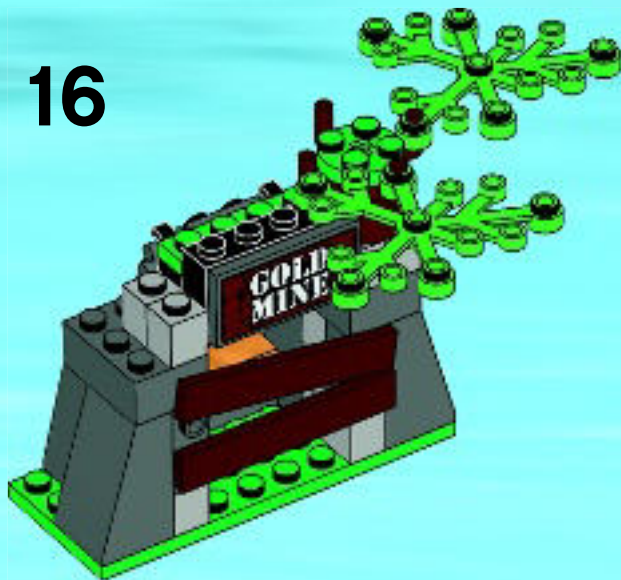

17

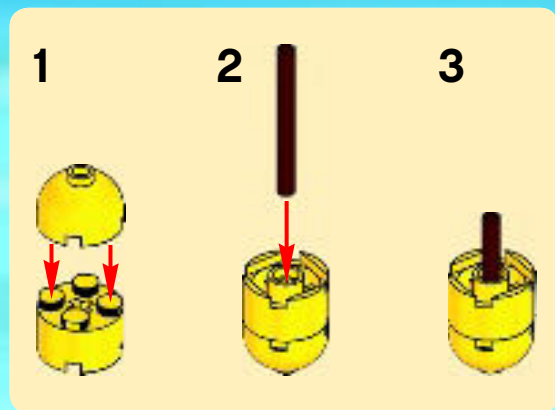
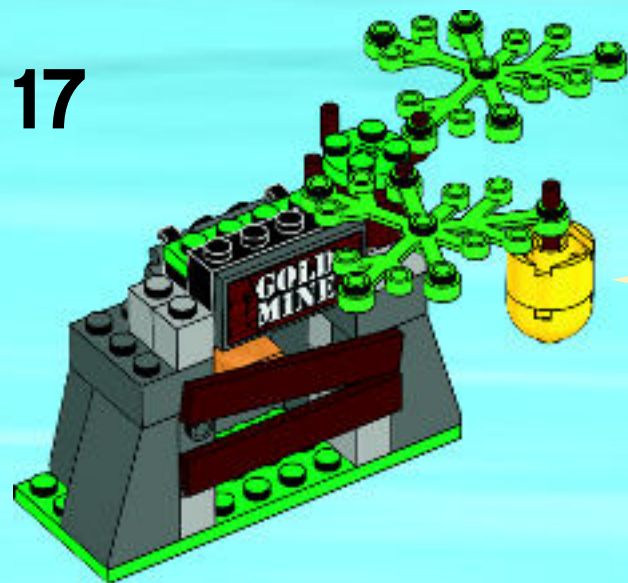

18



LEGO CITY

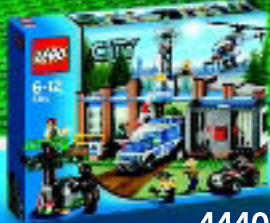

4440



4439



4441



4437



4436



CITY



4209



4208



4427



www.LEGOclub.com



LEGO® Club Email



LEGO® Club Magazine

LEGO club™

FREE! GRATIS! GRATUIT!

SIGN UP ONLINE!

www.LEGOclub.com



00800 5346 5555*



1-866-534-6258 • 1-877-518-5346

US & Canada only

Coût de l'appel

- * Freephone. Mobile charges may apply.
- * Numéro sans frais. Des frais peuvent s'appliquer avec les téléphones cellulaires.
- * Gebührenfrei, Kosten für Anrufe aus Mobilfunknetzen können abweichen.
- * Gratis telefoonnummer vanaf vaste lijn.
- * Det er et gratis nummer, når du ringer fra fasttelefon.
- * Det är gratis, när du ringer från en fast telefon.
- * Numéro sans frais. Des frais peuvent s'appliquer avec les téléphones portables.

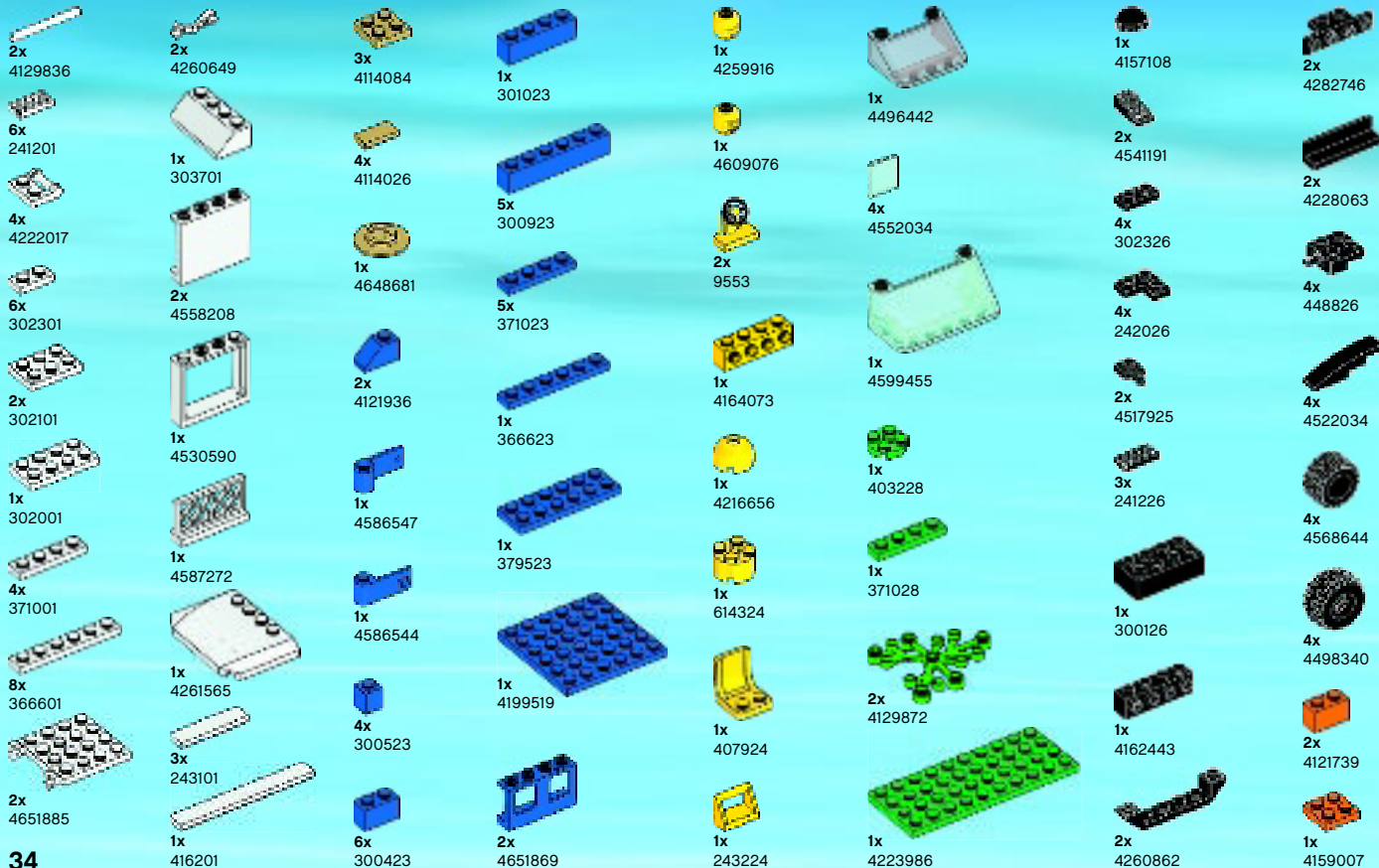



Customer Service
Kundenservice
Service Consommateurs
Servicio Al Consumidor

www.lego.com/service or dial



: 00800 5346 5555
 : 1-800-422-5346



WIN!

Go to www.LEGOsurvey.com/product to fill out a survey for a chance to win a cool LEGO® Product.

No purchase necessary.

Open to all residents where not prohibited.



www.LEGOsurvey.com/product

GEWINNE!

Nimm an der Umfrage auf www.LEGOsurvey.com/product teil und hab die Chance ein cooles LEGO® Produkt zu gewinnen!

Die Teilnahme am Gewinnspiel führt zu keinerlei Kaufverpflichtungen. Teilnahme in allen nicht ausgeschlossenen Ländern möglich.

WIN!

Ga naar www.LEGOsurvey.com/product, vul een enquêteformulier in en maak kans op een cool LEGO® product.

Geen aankoopverplichting. Iedereen mag deelnemen, uitgezonderd ingezetenden van landen waar een enquêteverbod geldt.

GAGNE!

Visite www.LEGOsurvey.com/product pour répondre à un questionnaire et avoir une chance de gagner un produit LEGO® très cool!

Aucune obligation d'achat. Ouvert à tous les résidents des pays autorisés.

当てよう!

www.LEGOsurvey.com/product にアクセスして、アンケートにご記入ください。当選者にはレゴ®製品を差し上げます。

お買い上げの必要はありません。禁止されていない限り、すべての皆様にご利用いただけます。



www.LEGO.com

6013617

LEGO and the LEGO logo are trademarks of the LEGO Group. ©2012 The LEGO Group.



CITY

4441





2

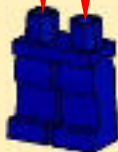

1



2

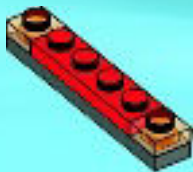

3

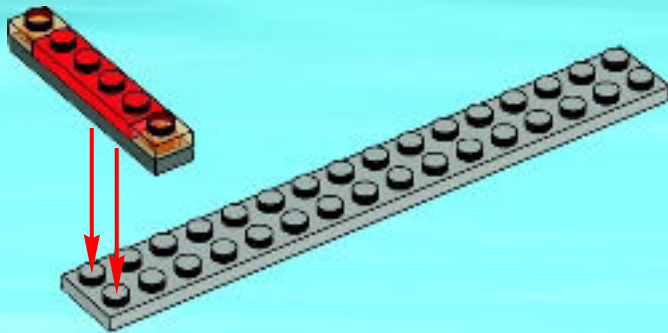

4

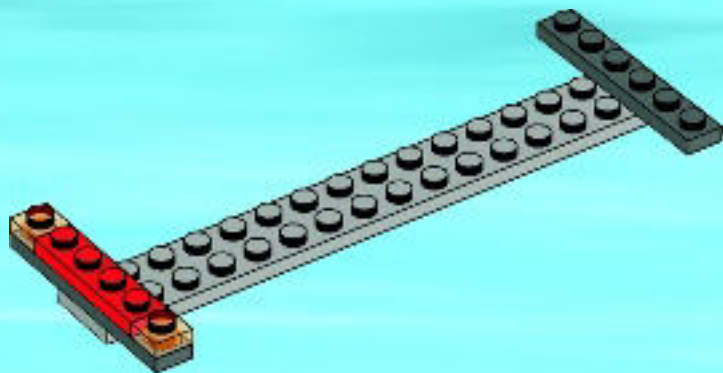

5

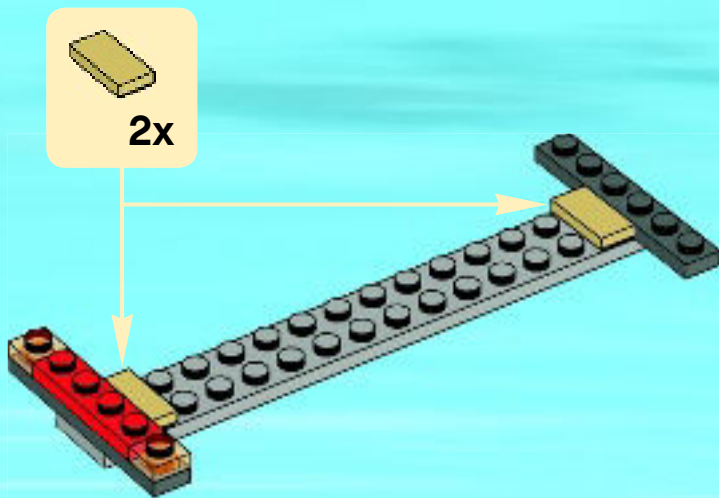

6

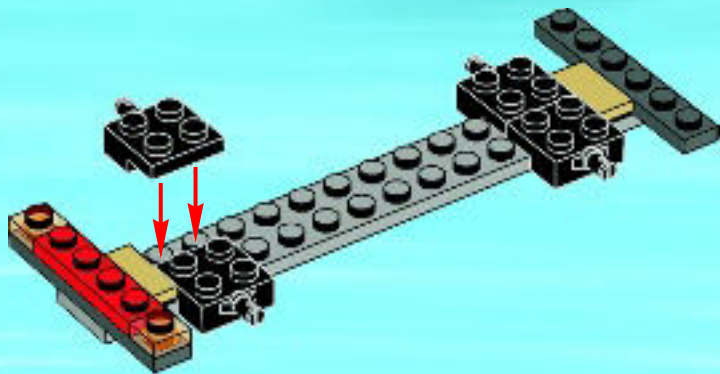

7

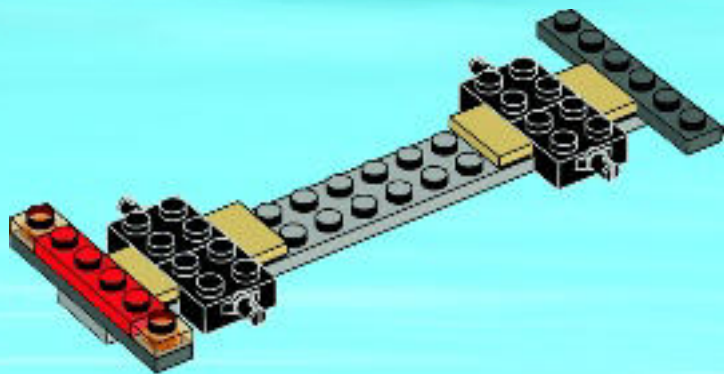

8

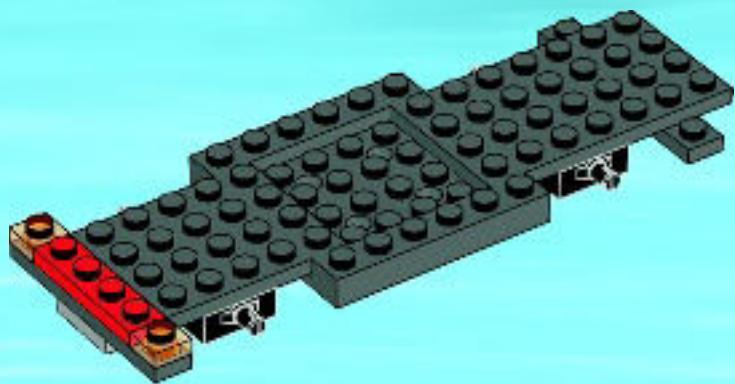

9

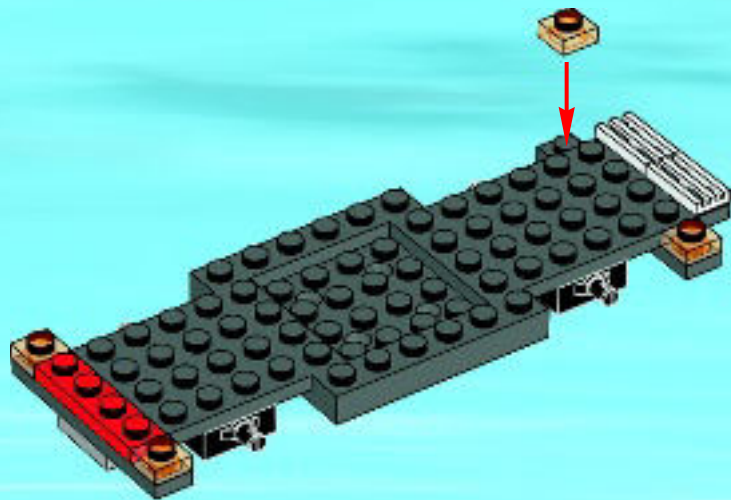

10

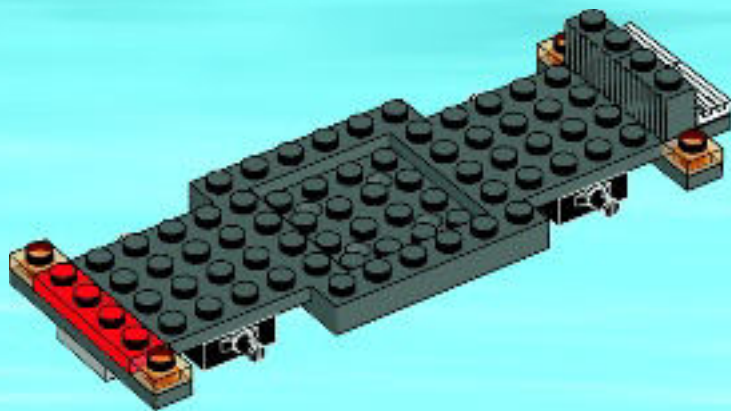

11

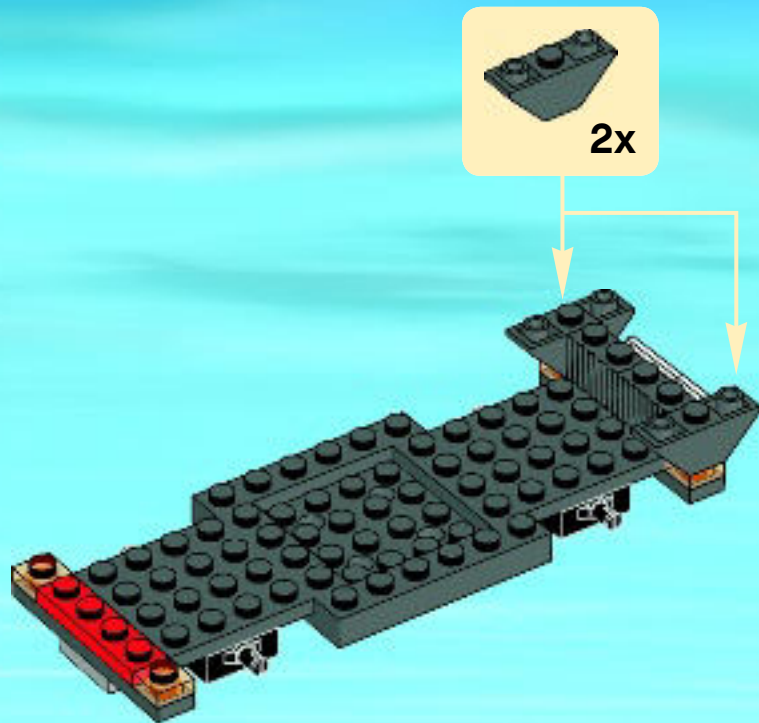

12

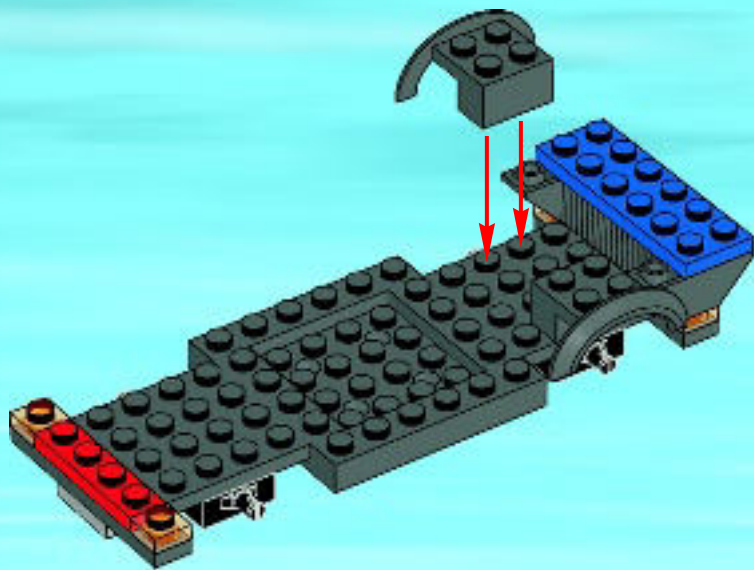

13

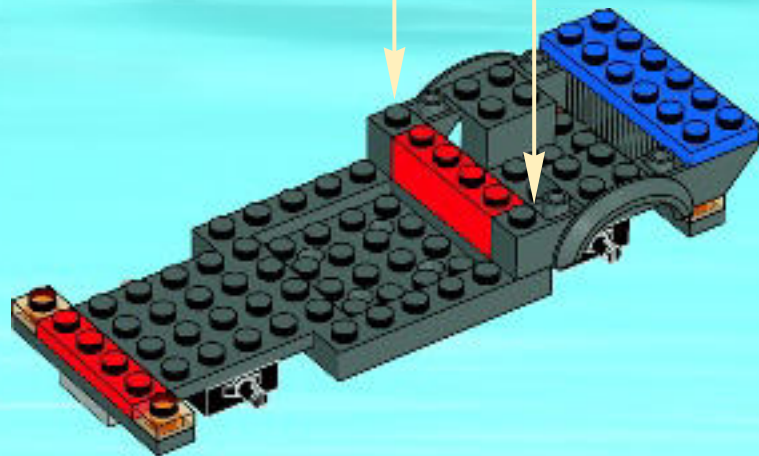

14

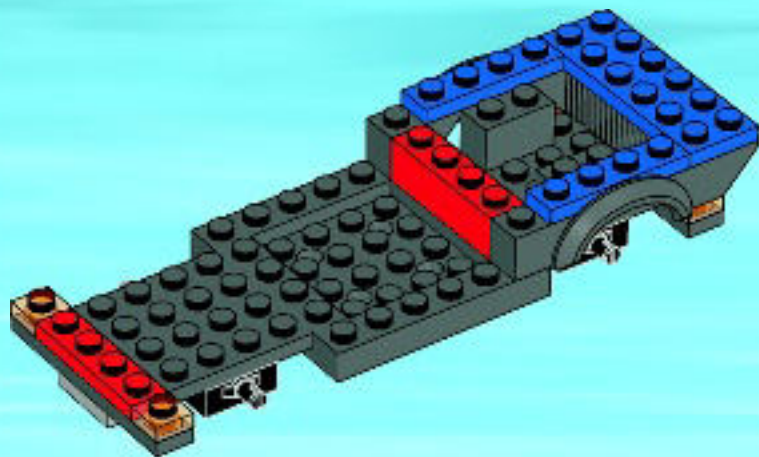

15

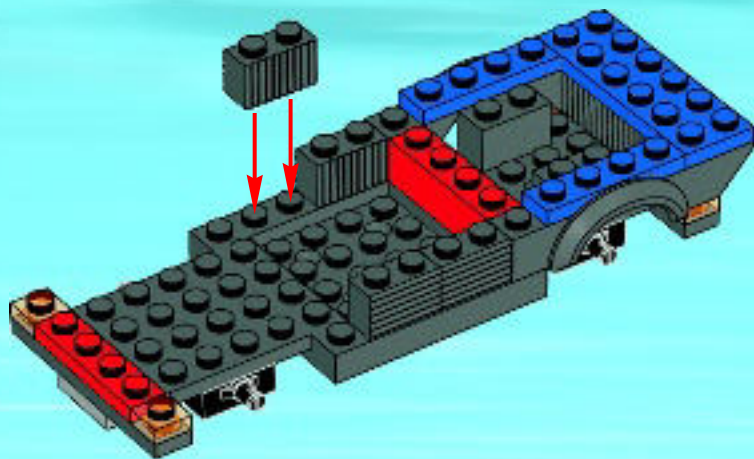

16

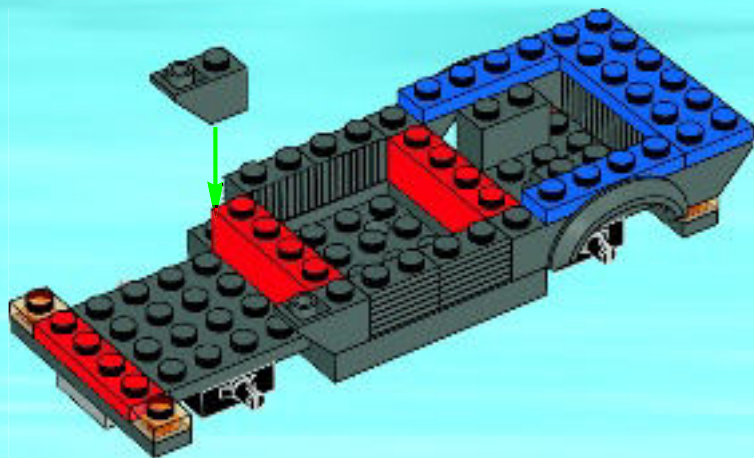

17

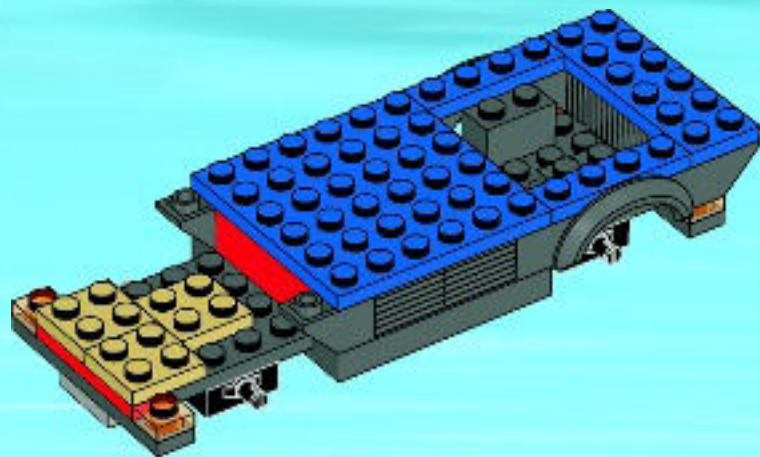

18

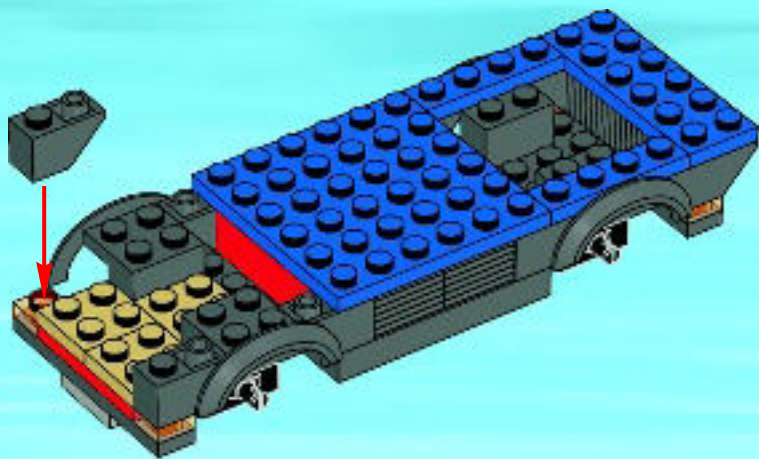

19

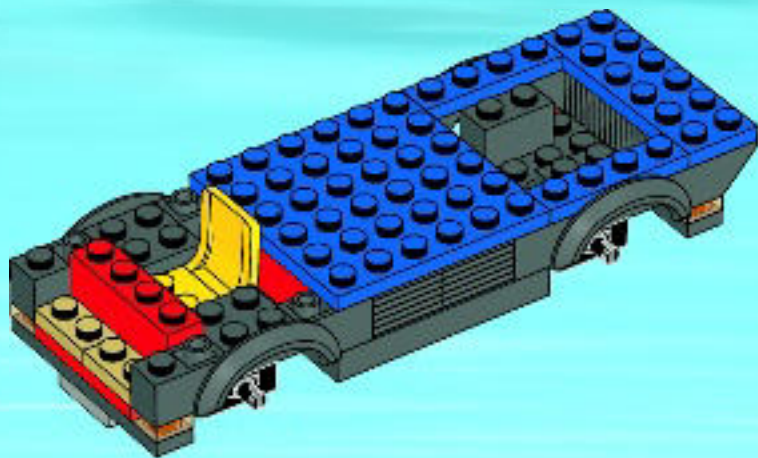

20

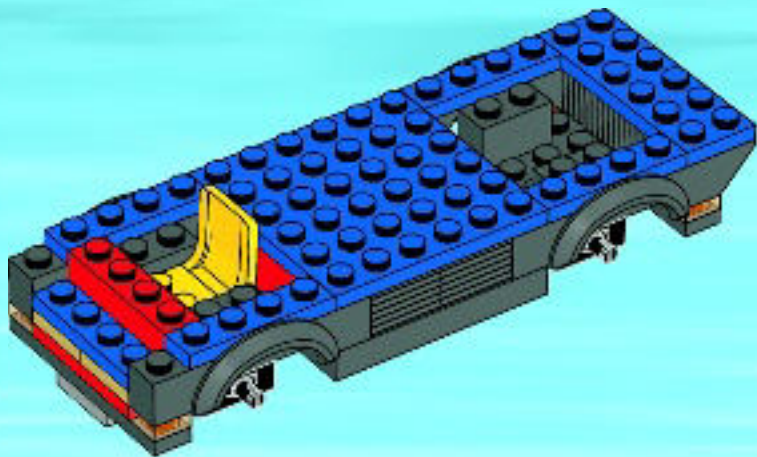

21

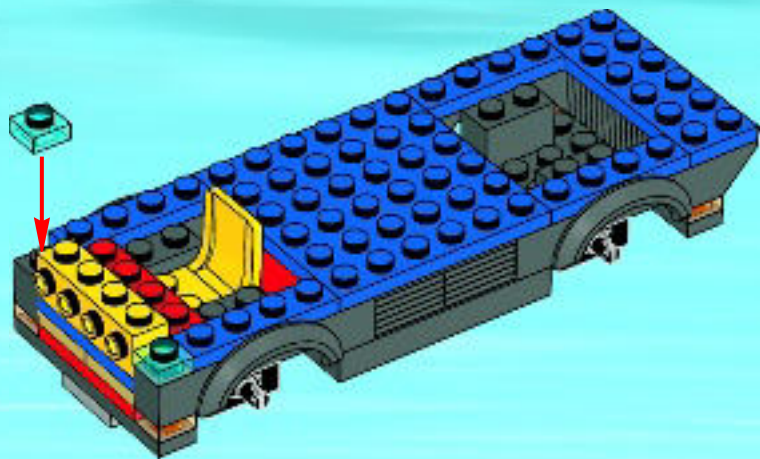

22

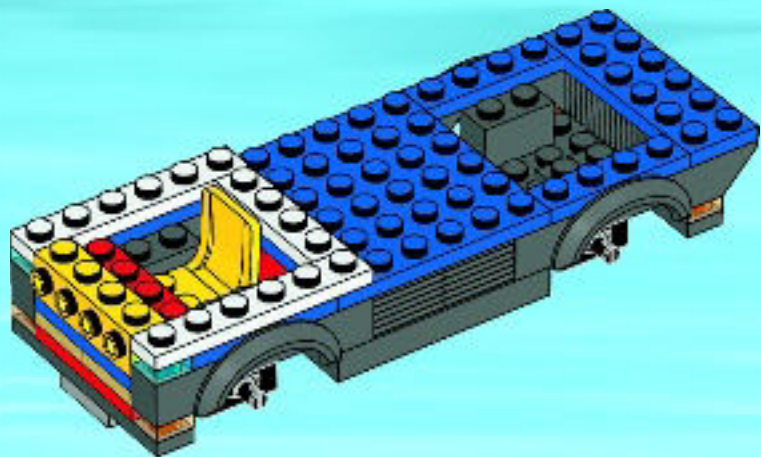

23

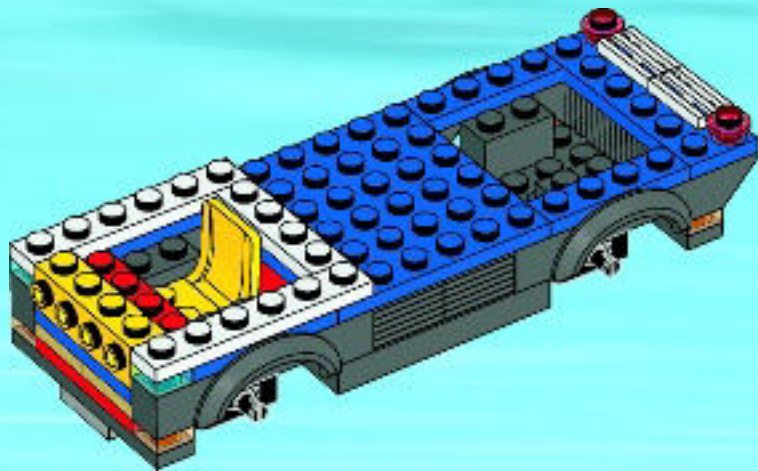

24

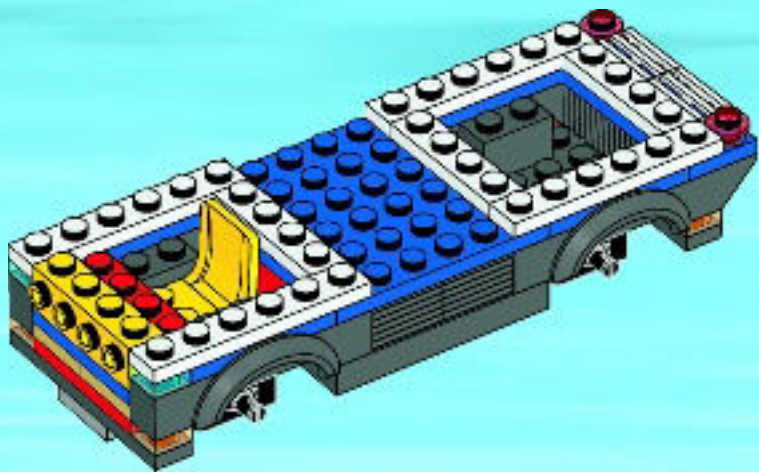

25

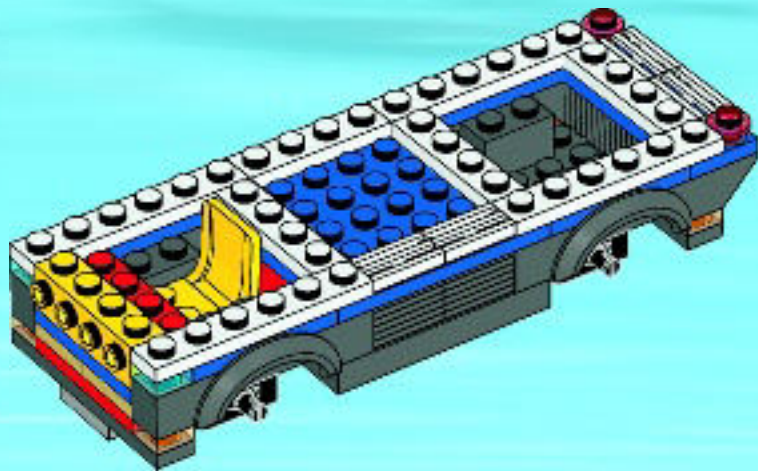

26

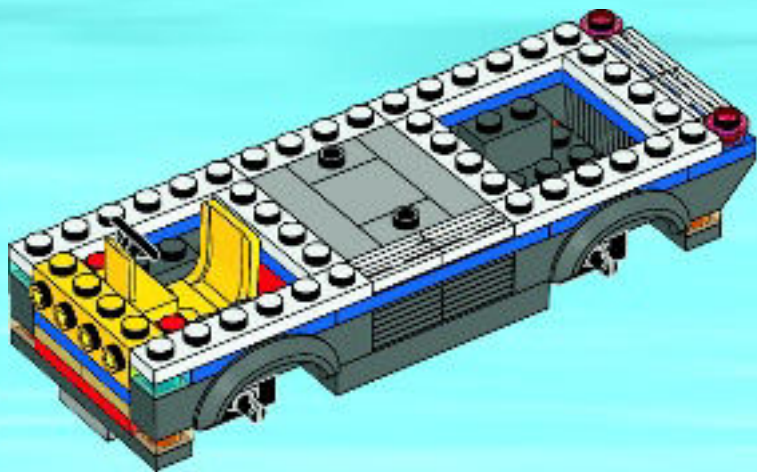



1



2

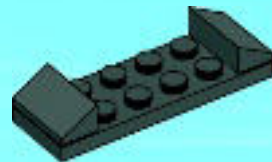

3

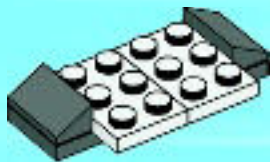

4



5



6



7

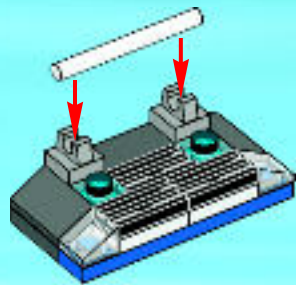

8

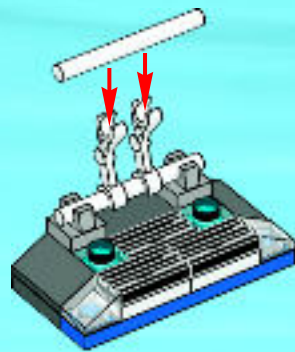

9



27

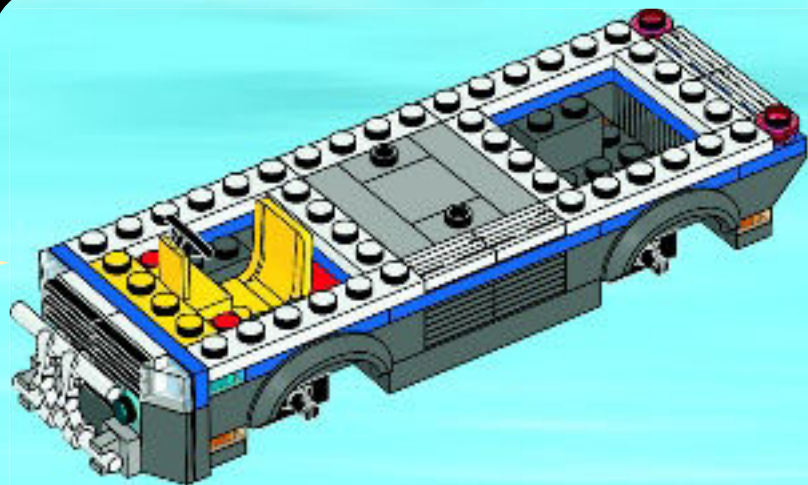

28

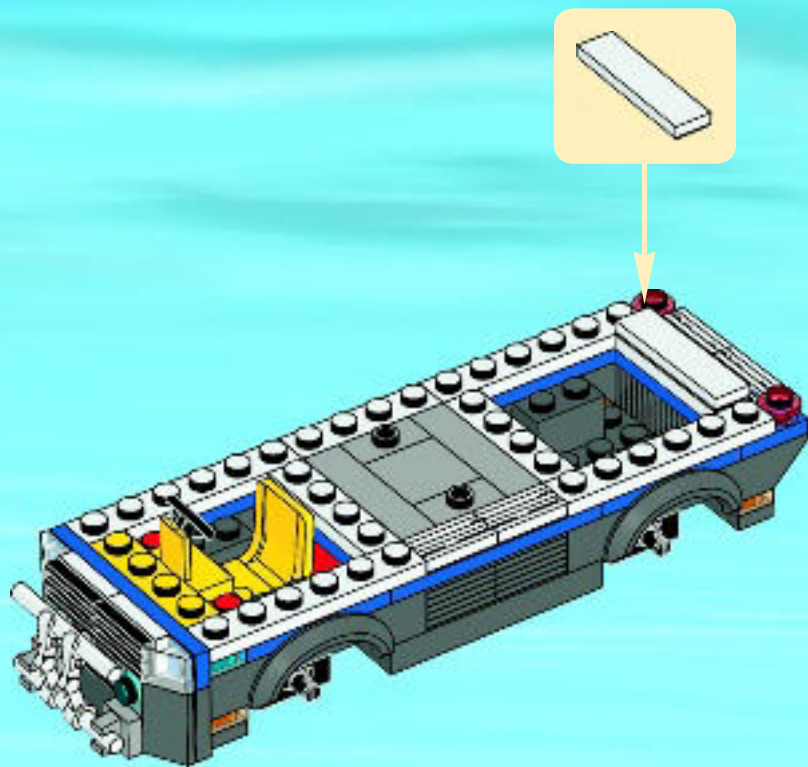

29

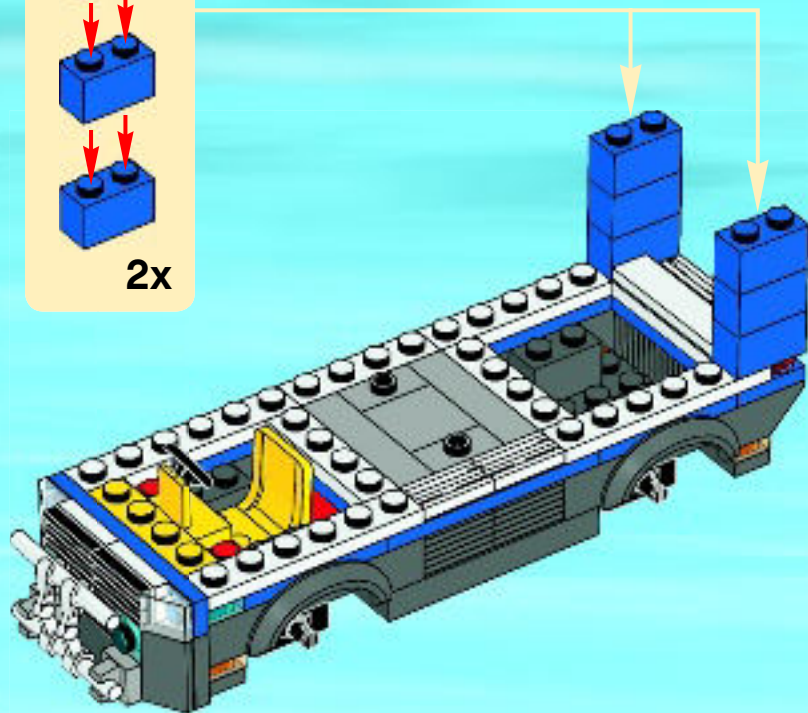
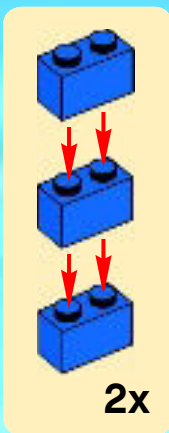

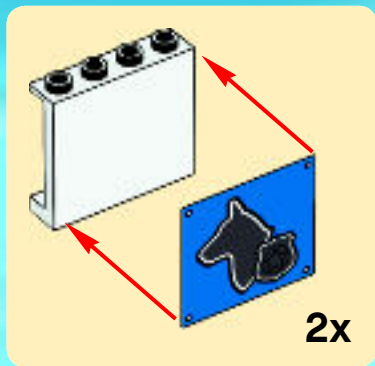

30

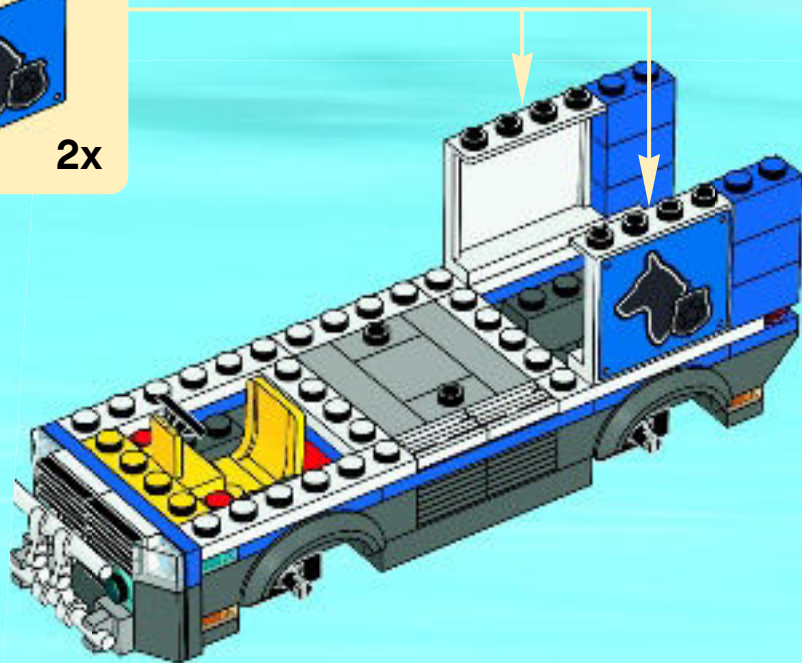

31

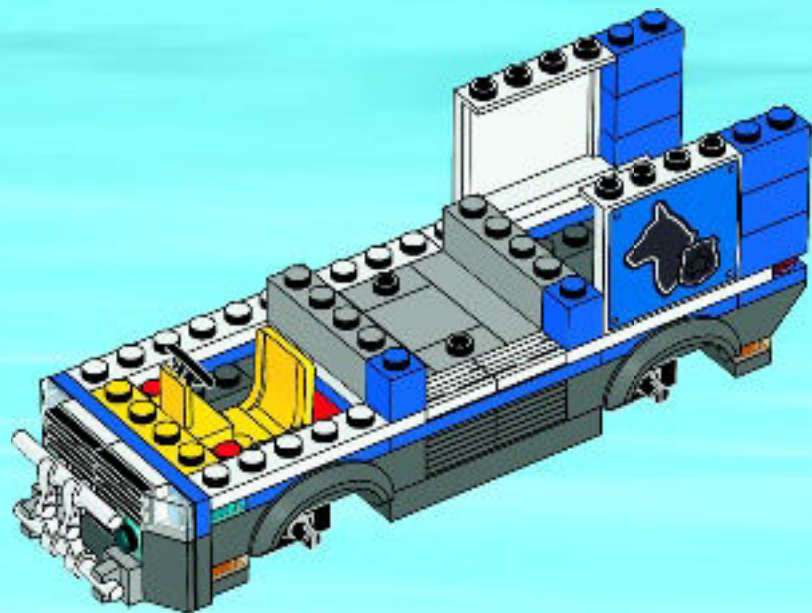

1

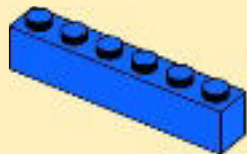

2



32

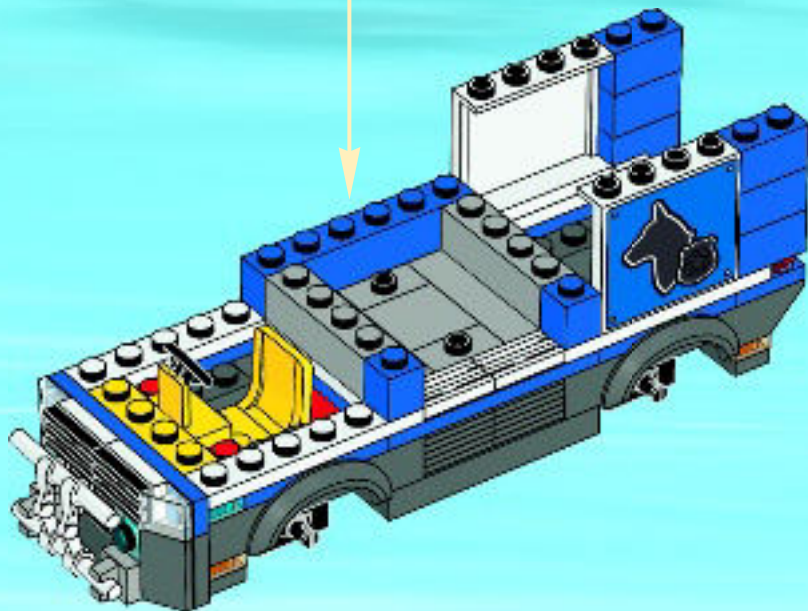

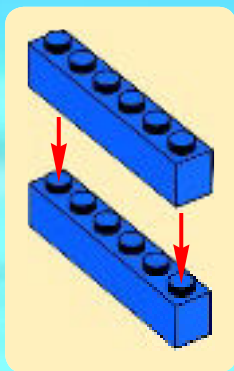

33

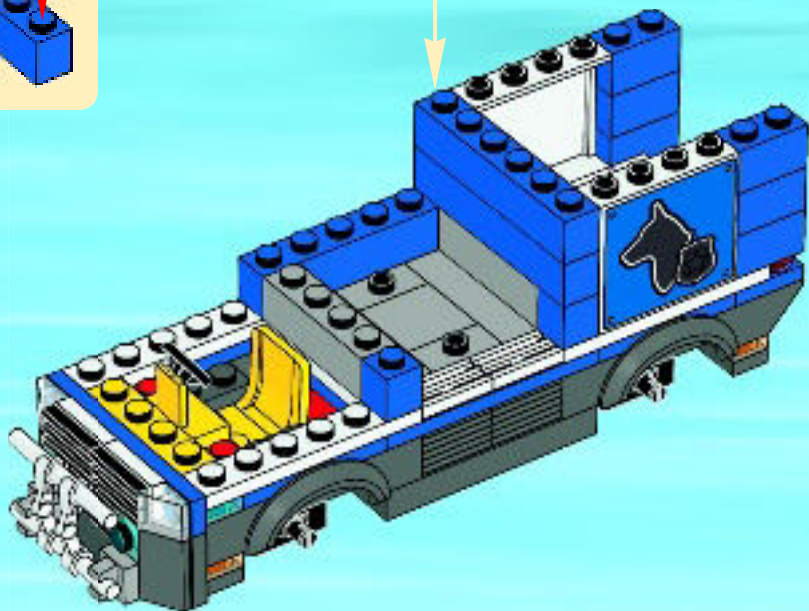

34

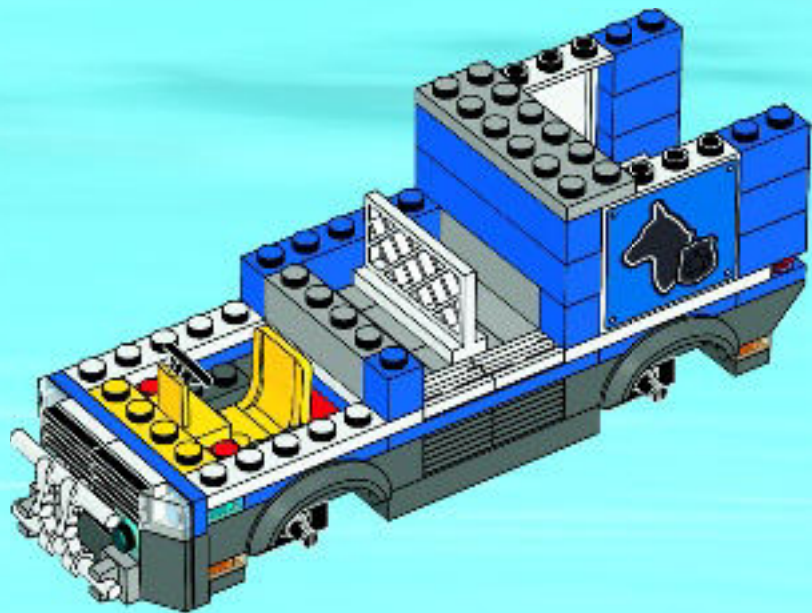

35

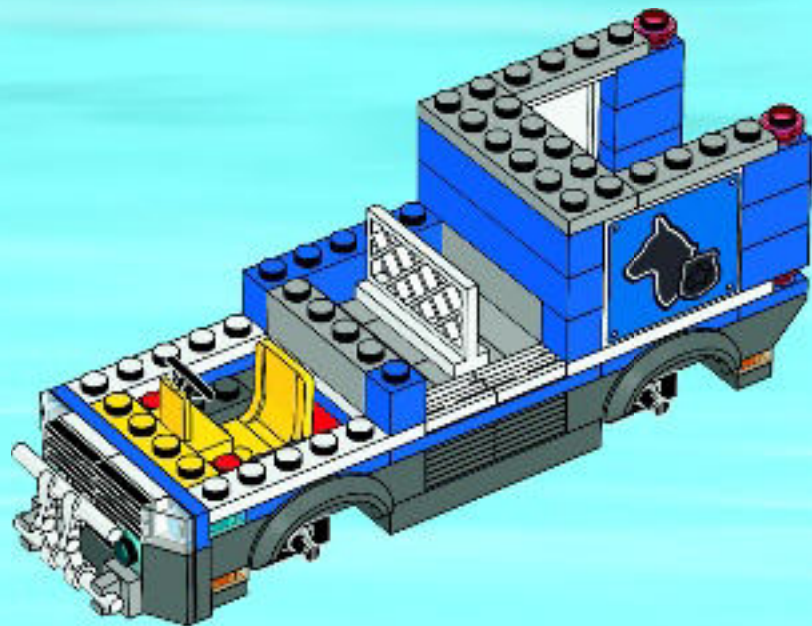

36

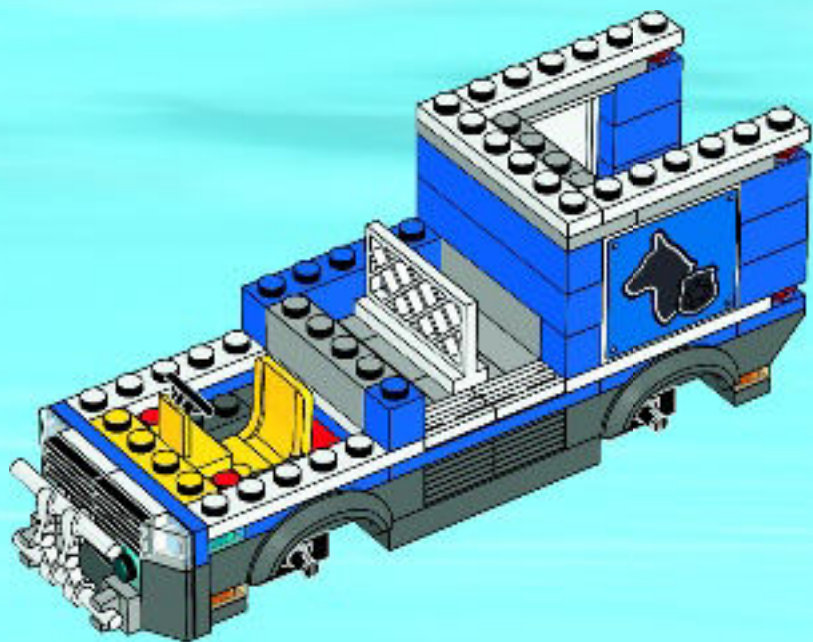

37

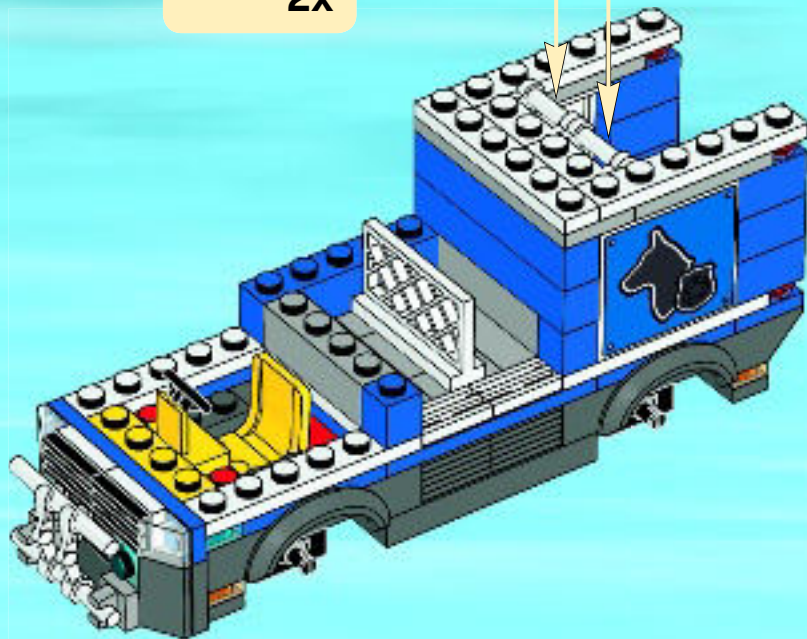

1

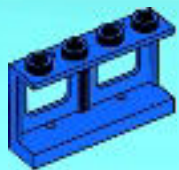

2

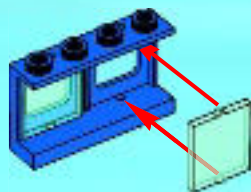

3



4



38

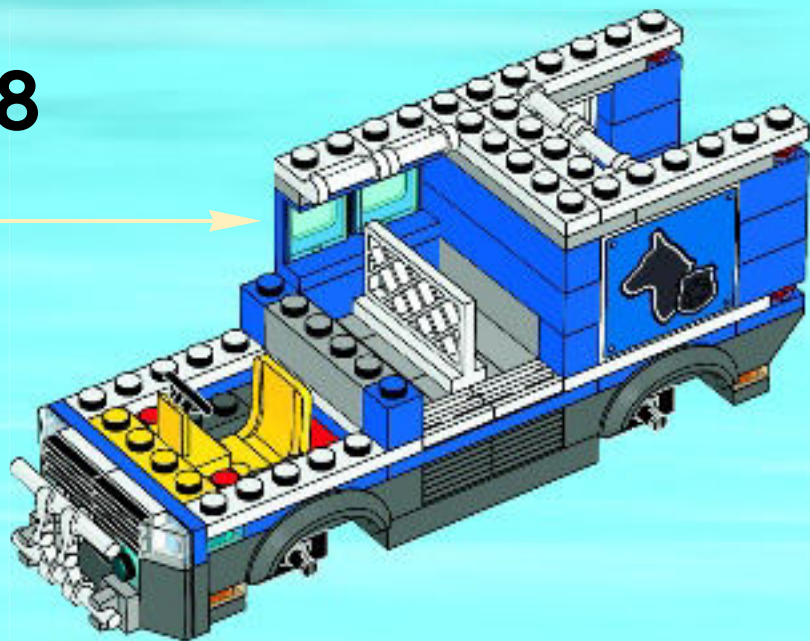

39

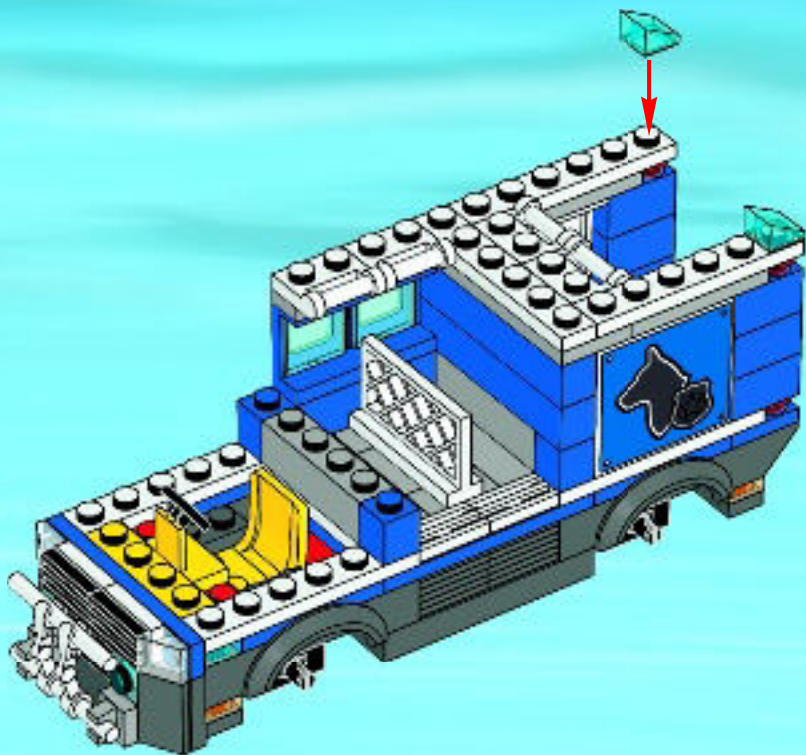

40

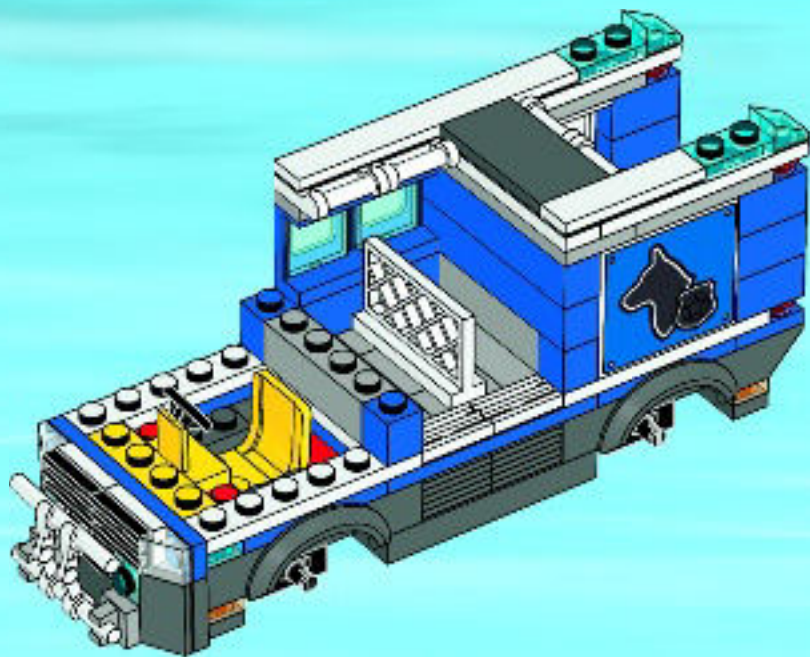

41

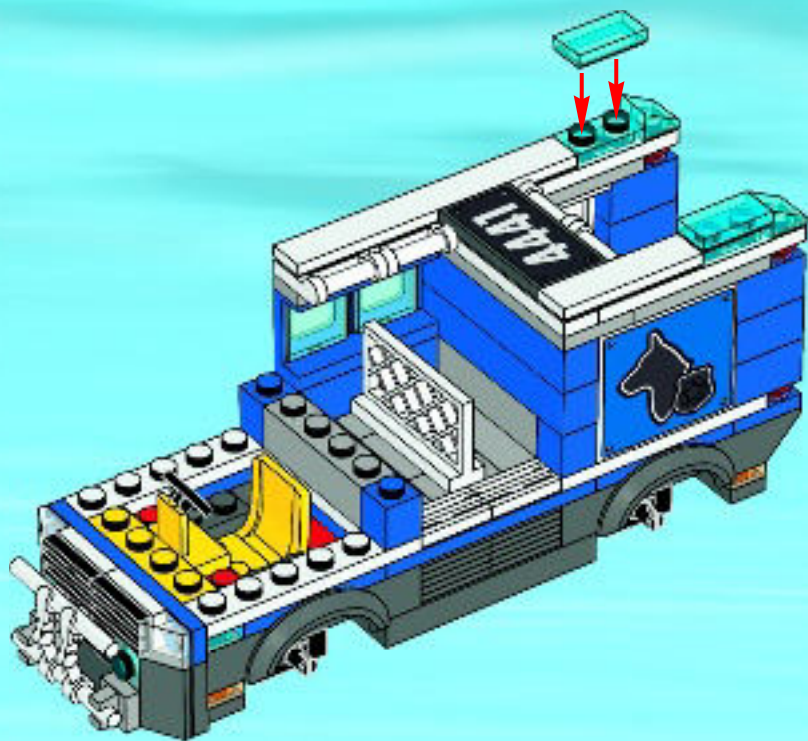

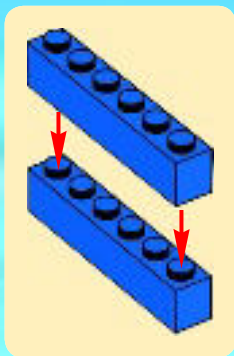

42

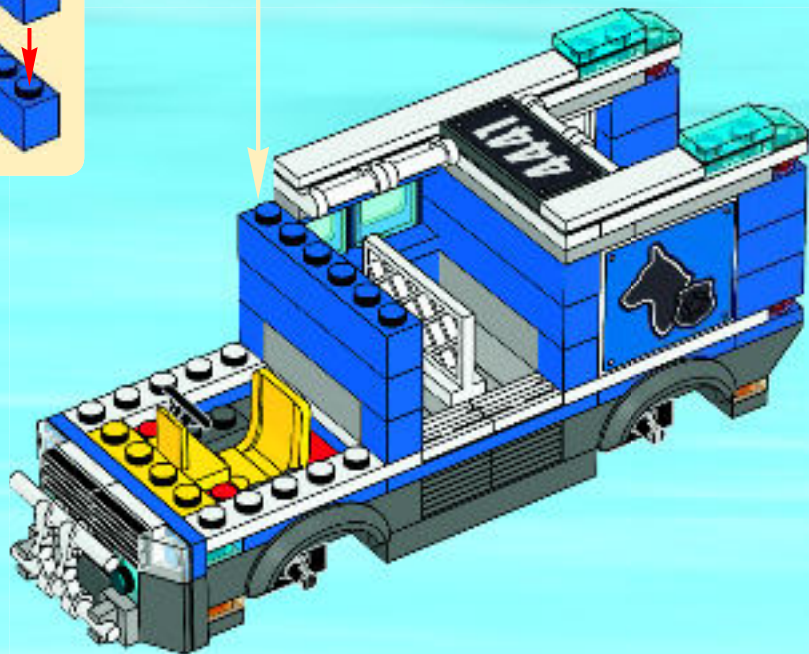

43

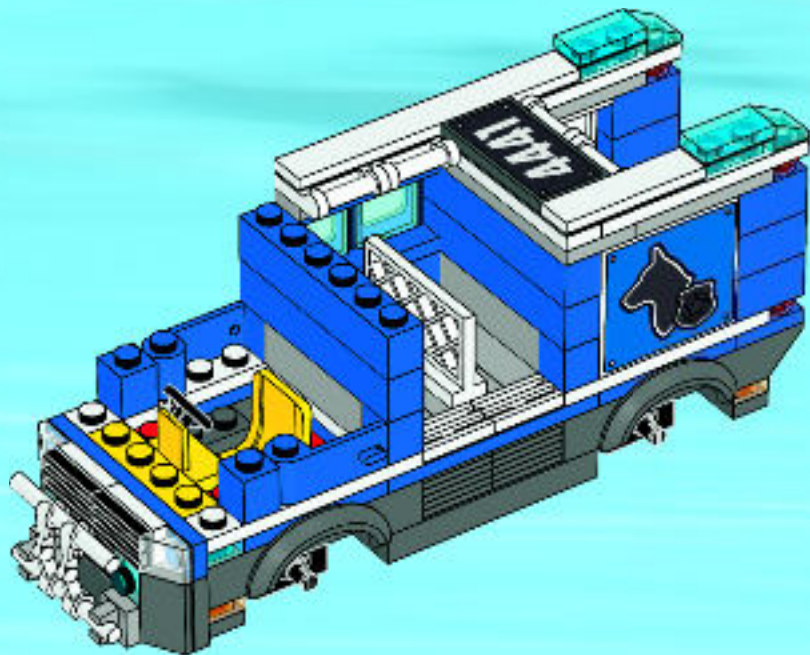

44

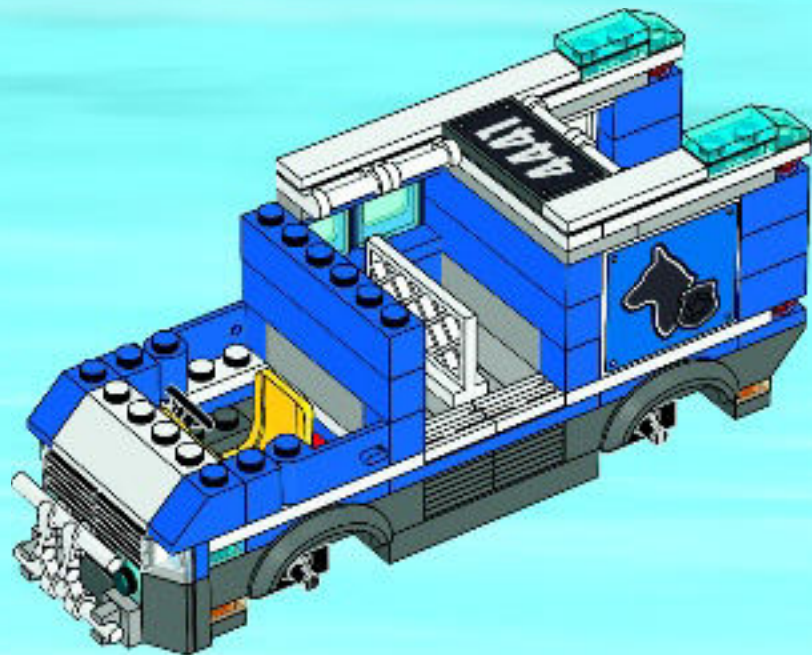

45

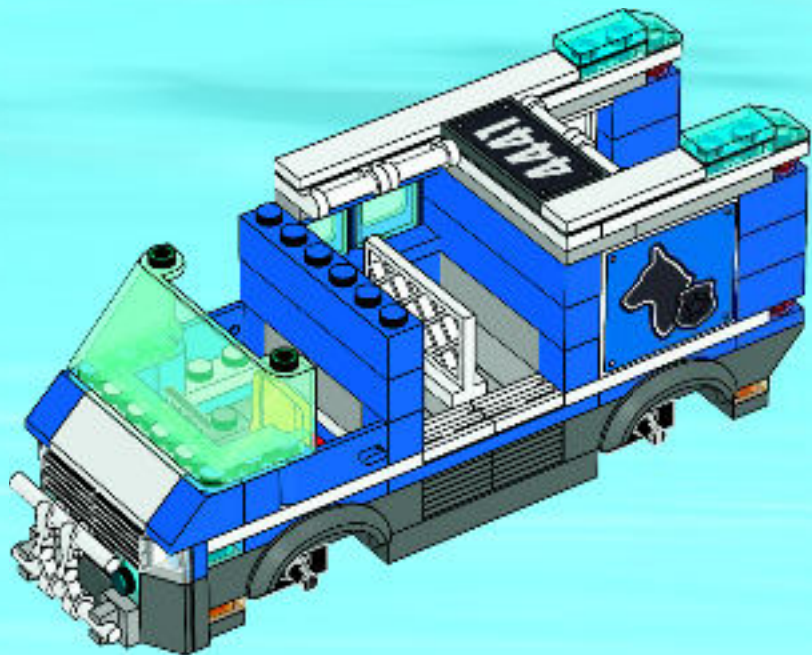

1

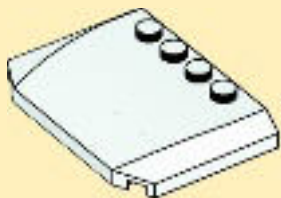

2

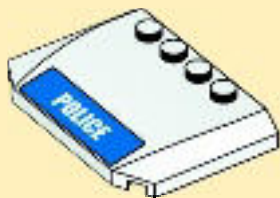

46

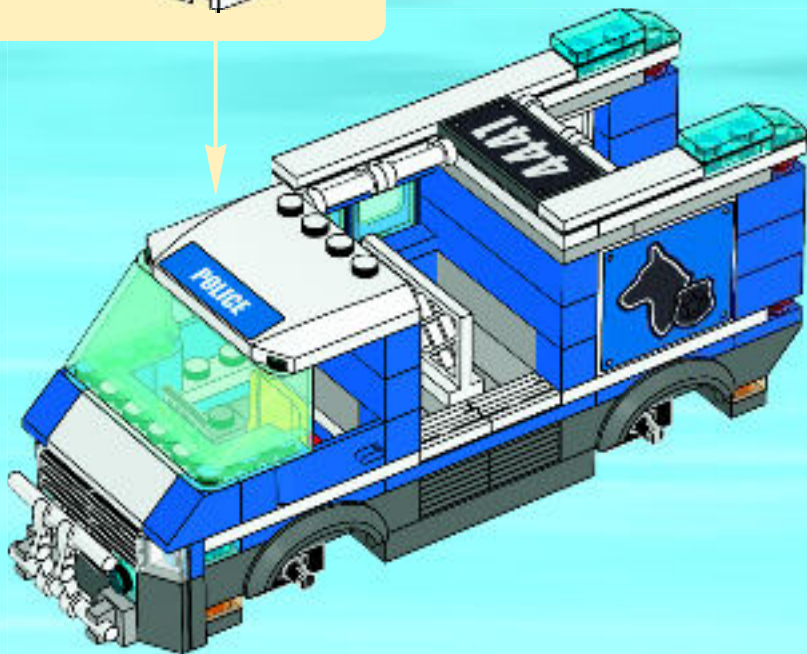



1

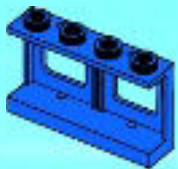

2

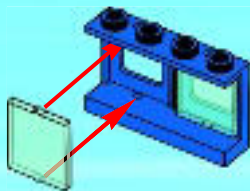

3



4



5



6



47

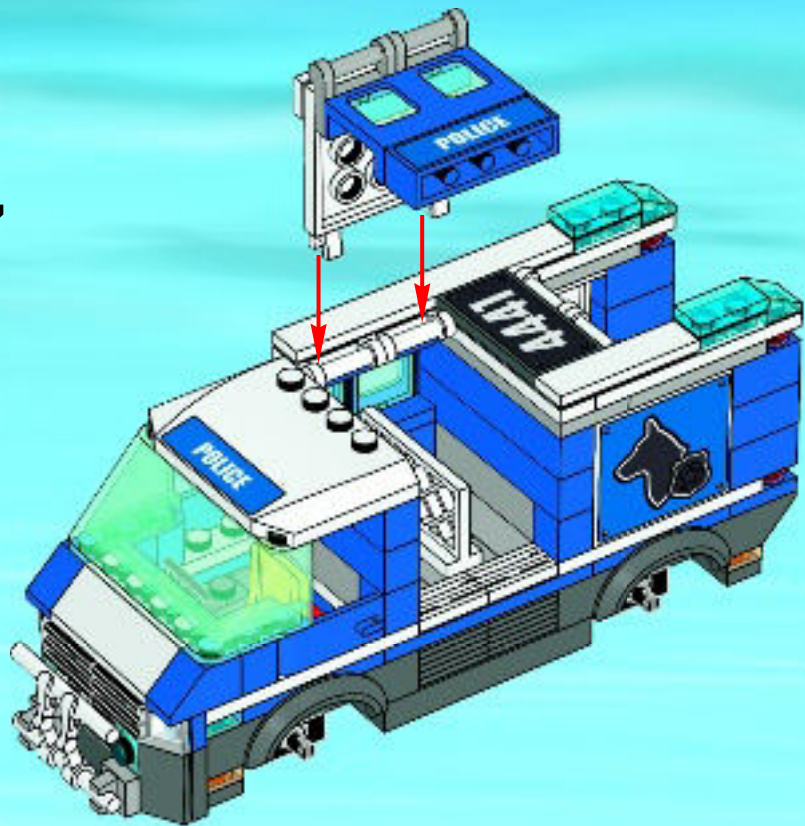



1



2

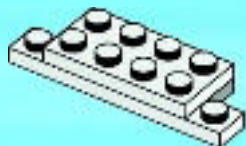

3

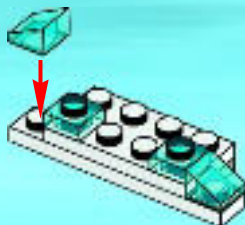

4

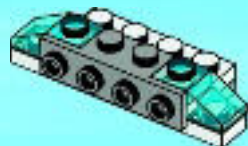

5



48

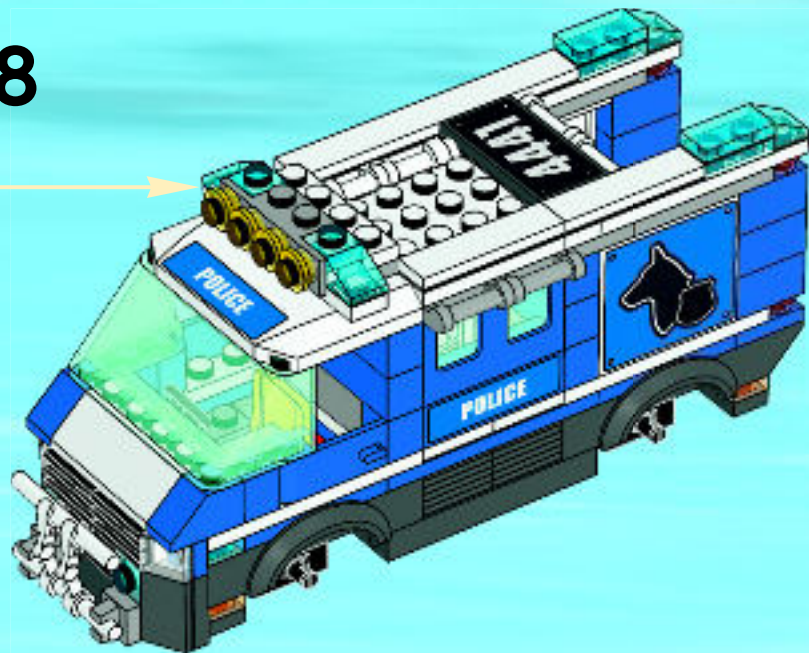



1

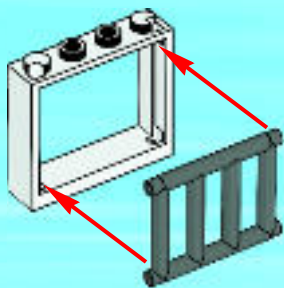

2

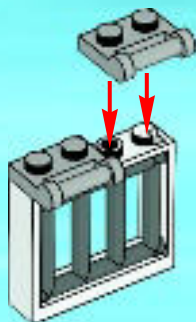

3



49



50

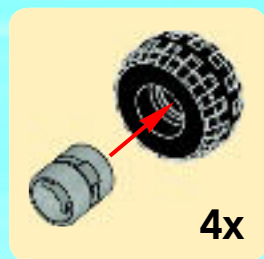

4x

51

